

4

3

2

1

D

C

B

A

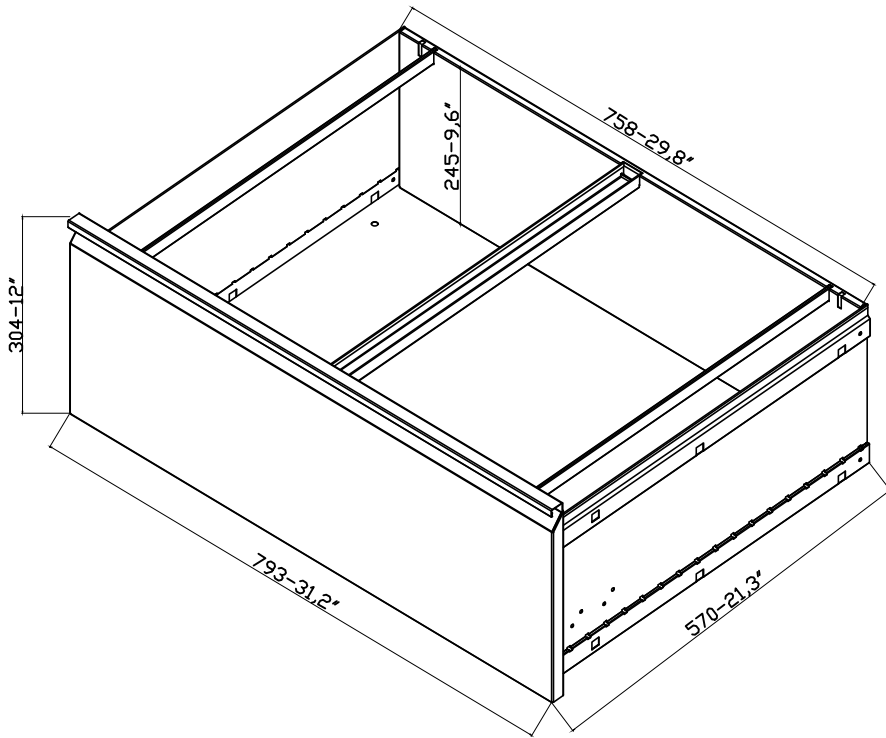
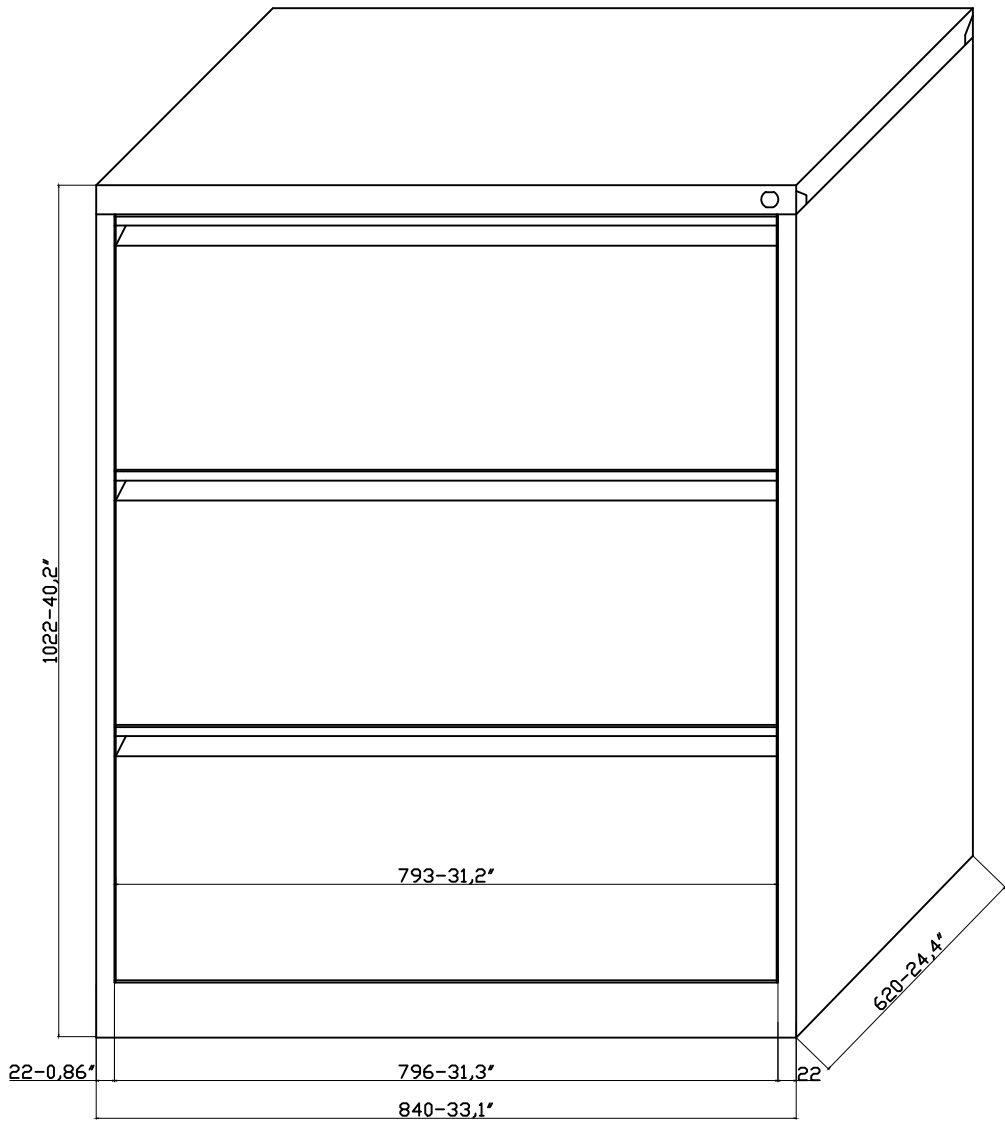

DRAWN BY ÇİZEN	DATE/ TARİH	SIGNATURE İMZA	PRODUCT NAME/ÜRÜN ADI: 52 702	CUTTING MEASURES/KESİM ÖLÇÜLERİ	
G.BARAN	12/11/2007		CHW2-100		
CHECKED BY KONTROL	14/11/2007		PIECE NAME/PARÇA ADI: MONTRES	PIECE OF DRAW SIZE/PARÇA RESİM NO	
A.ERDOGAN					
APPROVED BY ONAY	16/11/2007			REVISION/REVIZYON	SCALE/ÖLÇEK
A.ÖZDEN					

4

3

2

1